

Advanced Thermal Imaging Camera

G9700 Series - G9706

The thermographic handheld camera is based on the thermal technology, specially designed for the needs of temperature measuring applications. People can quickly troubleshoot faults on-site.



- Thermal resolution: 640 x 512 (327 680 pixels)
- NETD: < 35 mK (@ 25 °C, F#=1.0)
- Temperature measurement range: -20 °C to 650 °C (-4 °F to 1202 °F)
- Accuracy: Max (± 2 °C/3.6 °F, $\pm 2\%$)
- Measurement presets: Center spot, Hot spot, Cold spot, User Preset Point/Line/Area
- Auto/Manual/Laser focus
- 50 Hz image frequency
- 4.3" LCD touch screen display
- 8 MP optical camera
- Up to 4 hours continuous running

Dimensions

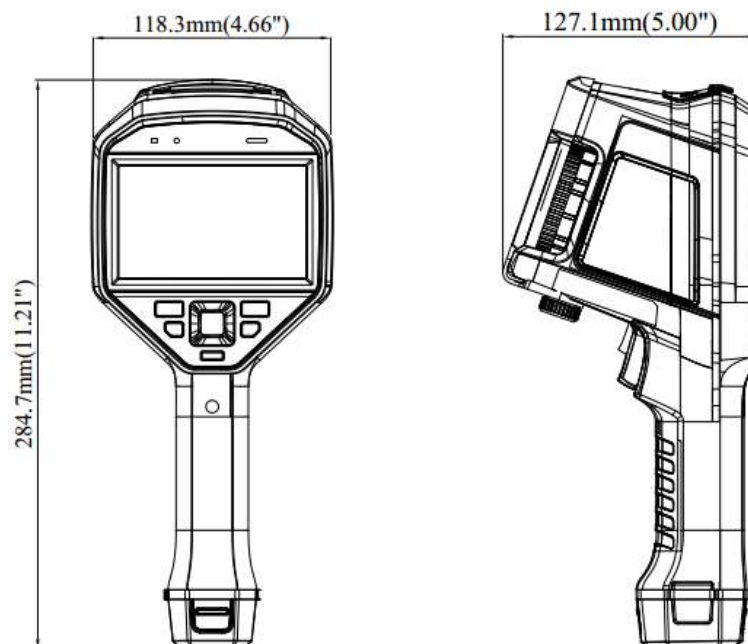

Specifications		Best Accuracy
Thermal Module	Image Sensor	Vanadium Oxide Uncooled Focal Plane Arrays
	IR Resolution	640 x 512 (327 680 pixels)
	Pixel Pitch	17µm
	Spectral Range	8µm to 14µm
	NETD	< 35 mK (@ 25 °C, F#=1.0)
	Focal Length	25 mm
	Field of View	25° × 19°
	Image Frequency	50 Hz
	Focus	Continuous Autofocus/Autofocus/Manual Focus/Laser Assisted Focus
	IFOV (Spatial Resolution)	0.68 mrad
	Aperture	F1.1
	Minimum Focus Distance	0.3 m (0.98 ft)
Optical Module	Picture Resolution	Configurable: 2 MP, 5 MP, 8 MP
	Video Resolution	640 x 480
	Focus	Fixed
	FOV	25° × 19°
Image Display	Display	800 x 480 resolution, 4.3" LCD touch screen
	Color Palettes	Black hot, White hot, Red hot, Rainbow, Ironbow, Fusion, Rain
	Digital Zoom	Thermal: 1x, 2x, 4x, 8x
	Image Modes	Thermal/Optical/Fusion image/Picture in Picture
	Picture in Picture	Thermal Picture in Optical Picture
	Fusion	Thermal Picture and Optical Picture Combined
Measurement and Analysis	Object Temperature Range	-20 °C to 650 °C (-4 °F to 1202 °F)
	Accuracy	Max (±2°C/3.6°F, ±2%)
	Measurement Presets	Center Spot, Hot Spot, Cold Spot, Off
	Point	10 User Presets
	Line	1 User Presets
	Area	3 User Presets
	High Temperature Alarm	Audible Warning
Storage	Color Alarm (Isotherm)	Above/Below/Interval/Insulation
	Storage Media	Removable Micro SD Card (64 GB)
	Image Storage Capacity	60,000 Images
	Image File Format	JPEG with Measurement Data Included
	Video Storage Capacity	54 Hours

Packing List

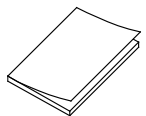

Quick Start Guide (x1)



Type-C Cable (x1)



Hand Strap (x1)



CVBS Cable (x1)

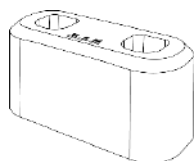

Charging Base (x1)

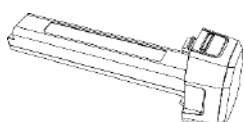

Battery (x2)



Micro SD Card (x1)

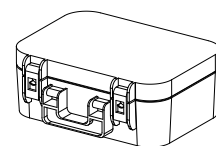

Box (x1)

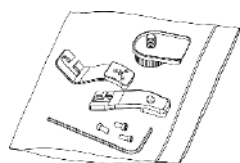

Tools Package (x1)

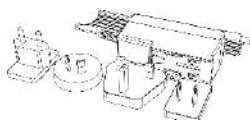

Charger (x1)

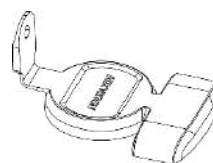

Lens Cover (x1)

Optional



Teleconverter 0.5x



Teleconverter 2x



Teleconverter 3.3x